

40mm sq.

San Ace 40

10mm thick (9P type), 15mm thick (9GA type),
 15mm thick (9P type), 20mm thick (9GA type),
 20mm thick (9P type), 28mm thick (9GA type),
 28mm thick (9GE type), 28mm thick (9GV type),
 28mm thick (9P type)



General Specifications

- Material Frame: Plastics (Flammability: UL94V-0),
 Impeller: Plastics (Flammability: UL94V-0)
- Expected Life Refer to specifications (L10: Survival rate: 90% at 60°C ,
 rated voltage, and continuously run in a free air state)
- Lead Wire ⊕red ⊖black (Sensor) yellow (Control) brown
- Storage Temperature -30°C to +70°C (Non-condensing)

40×40×28mm (Mass : 53g) **9GA type** **Low Power Consumption Fan**



Specifications

The following nos. **have PWM controls, pulse sensors, and ribs.** For ribless, append "1" to the model no.

Model No.	Rated Voltage [V]	Operating Voltage Range [V]	PWM duty cycle※ [%]	Rated Current [A]	Rated Input [W]	Rated Speed [min ⁻¹]	Max. Airflow [m ³ /min] [CFM]	Max. Static Pressure [Pa] [inchH ₂ O]	SPL [dB(A)]	Operating Temperature [°C]	Expected Life [h]				
9GA0412P3K01	12	10.8 to 13.2	100	0.92	11.04	22,000	0.81 28.6	799 3.21	61	-20 to +60	30,000				
			0	0.10	1.2	6,500	0.23 8.12	68 0.27	32						
9GA0412P3J01			100	0.49	5.88	18,000	0.67 23.7	535 2.15	54			-20 to +70	40,000		
			0	0.05	0.6	4,500	0.16 5.7	33 0.13	22						
9GA0412P3G01			100	0.39	4.68	16,500	0.61 21.5	450 1.81	53						
			0	0.05	0.6	4,500	0.16 5.7	33 0.13	22						
9GA0412P3H01			100	0.28	3.36	14,500	0.54 19.1	347 1.39	50						
			0	0.04	0.48	3,500	0.13 4.6	20 0.08	17						
9GA0412P3M01			100	0.21	2.52	12,500	0.46 16.2	258 1.04	47						
			0	0.04	0.48	3,500	0.13 4.6	20 0.08	17						
9GA0424P3J001 ^(Note)			24	21.6 to 26.4	100	0.27	6.48	18,000	0.67 23.7	535 2.15	54			-20 to +70	40,000
9GA0424P3G001 ^(Note)					100	0.22	5.28	16,500	0.61 21.5	450 1.81	53				
9GA0424P3H001 ^(Note)	100	0.16			3.84	14,500	0.54 19.1	347 1.39	50						
9GA0424P3M001 ^(Note)	100	0.11			2.64	12,500	0.46 16.2	258 1.04	47						
	100	0.11			2.64	12,500	0.46 16.2	258 1.04	47						

Note: Rated voltage 24V fans do not rotate when PWM duty cycle is 0% .

※PWM Frequency : 25kHz

Some models can also be equipped without sensors or with pulse sensors (no PWM control functions) as an option. Please refer to the index (pp. 417 to 437).

Dimensions (unit : mm) (With ribs)

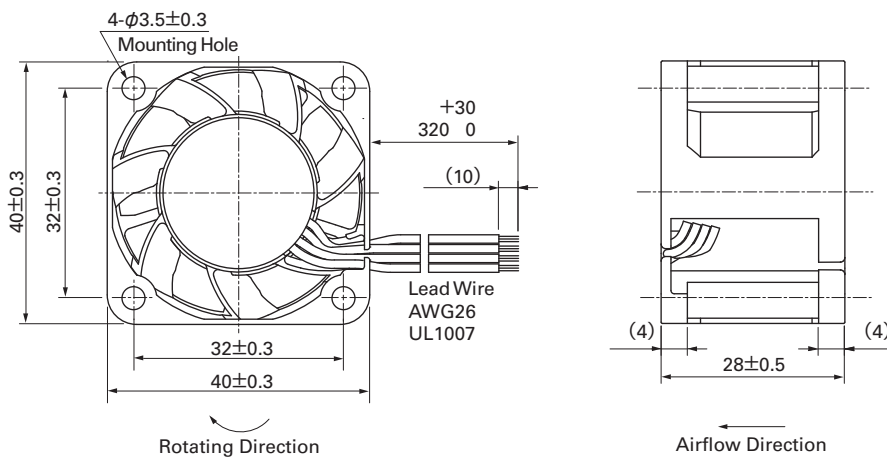

Reference Dimension of Mounting Holes and Vent Opening (unit : mm)

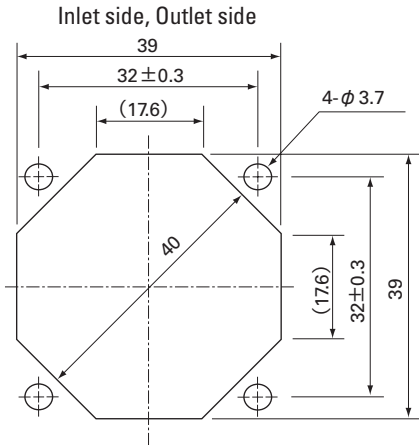

Options (unit : mm)

Finger Guards

Model : 109-059 Surface treatment : Nickel-chrome plating (silver)
: 109-059H Color : Cation electropainting (black)

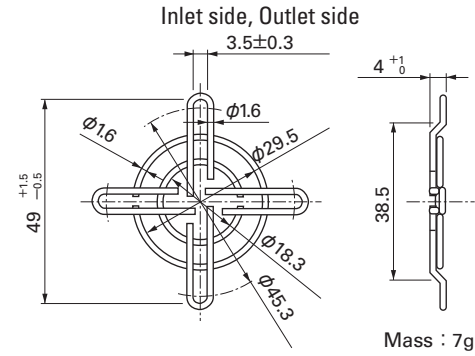

Airflow - Static Pressure Characteristics

PWM Duty Cycle

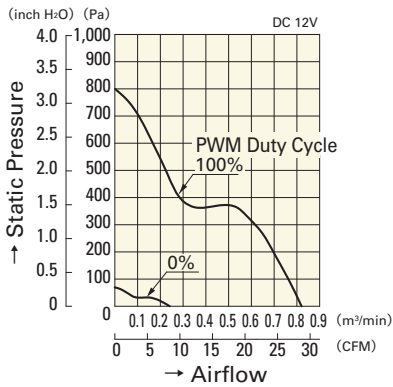

9GA0412P3K01

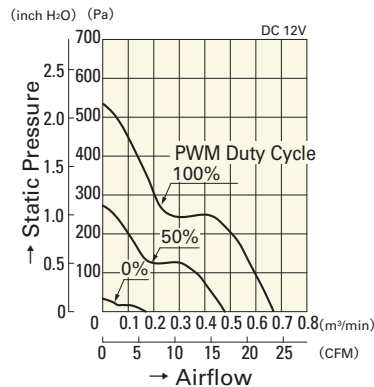

9GA0412P3J01

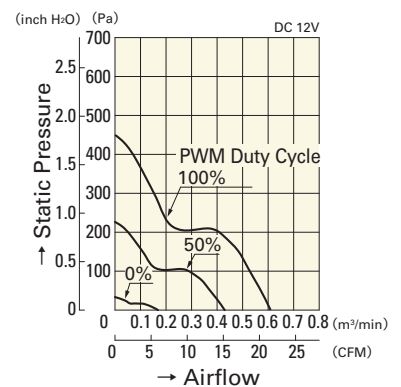

9GA0412P3G01

Operating Voltage Range

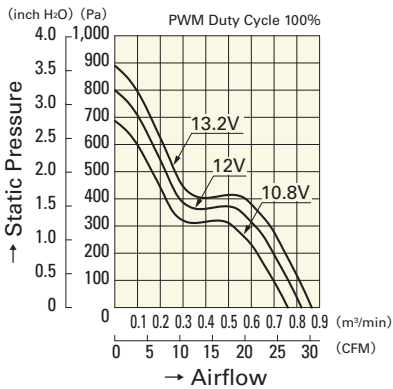

9GA0412P3K01

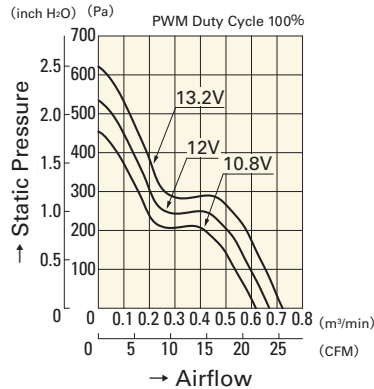

9GA0412P3J01

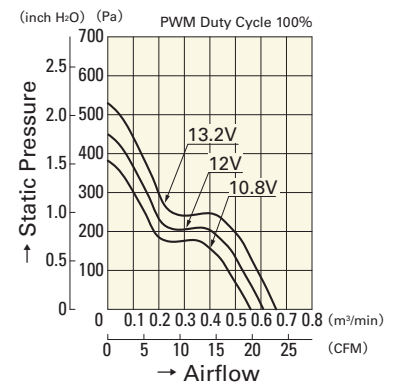

9GA0412P3G01

PWM Duty - Speed Characteristics Example

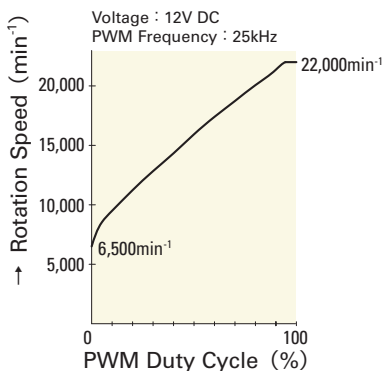

9GA0412P3K01

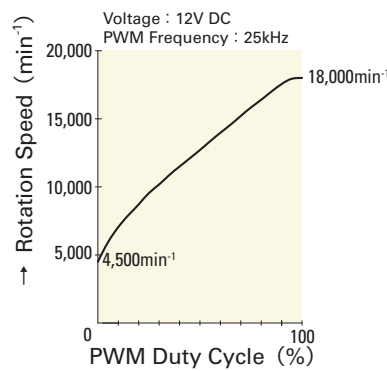

9GA0412P3J01

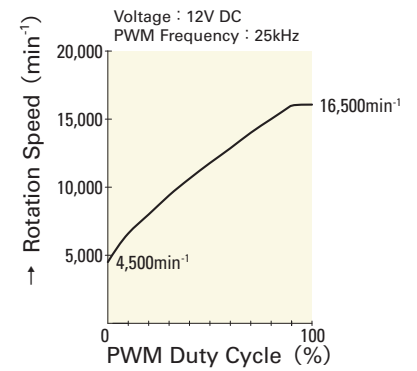

9GA0412P3G01

40mm sq.

San Ace 40

40×40×28mm [Mass : 53g]

Airflow - Static Pressure Characteristics

PWM Duty Cycle

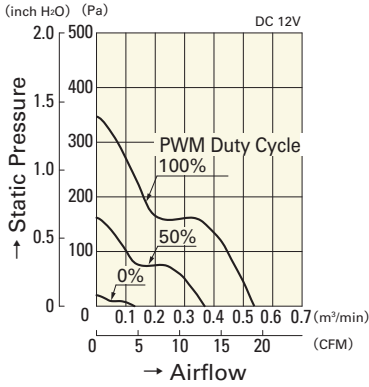

9GA0412P3H01

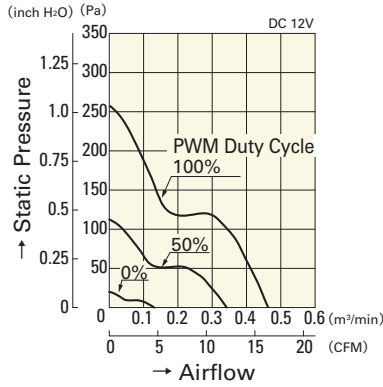

9GA0412P3M01

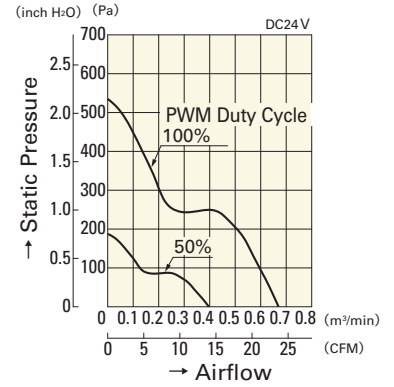

9GA0424P3J001

Operating Voltage Range

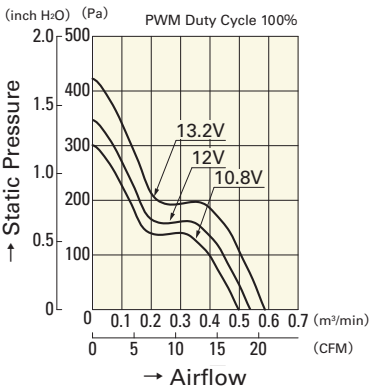

9GA0412P3H01

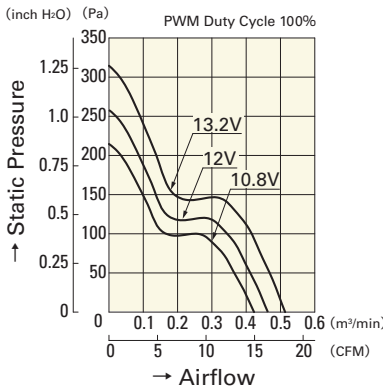

9GA0412P3M01

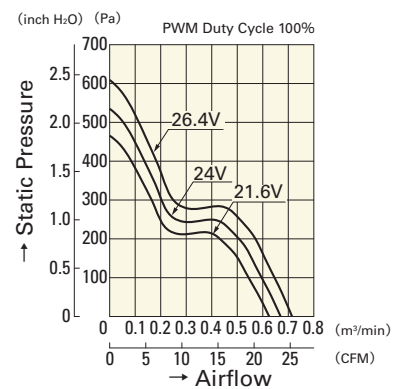

9GA0424P3J001

PWM Duty - Speed Characteristics Example

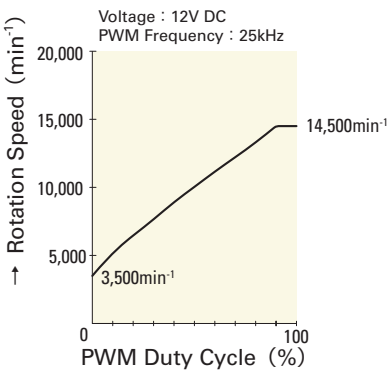

9GA0412P3H01

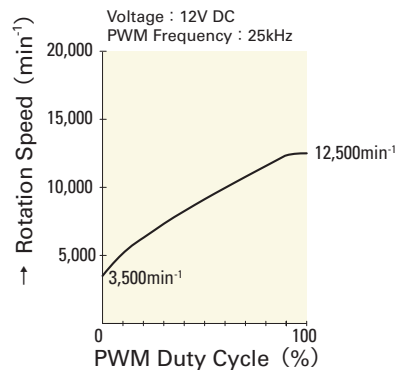

9GA0412P3M01

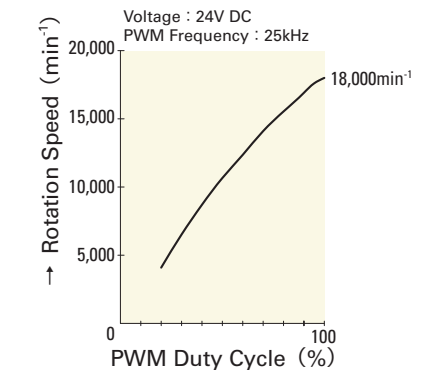

9GA0424P3J001

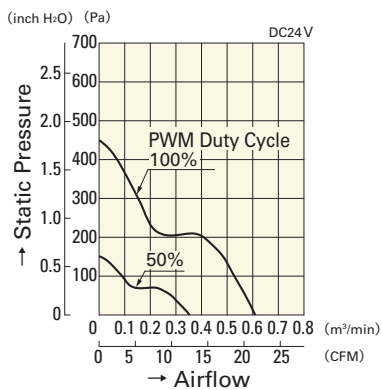

9GA0424P3G001

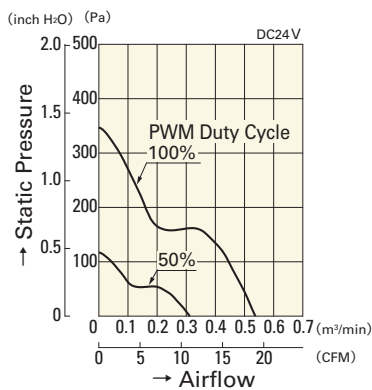

9GA0424P3H001

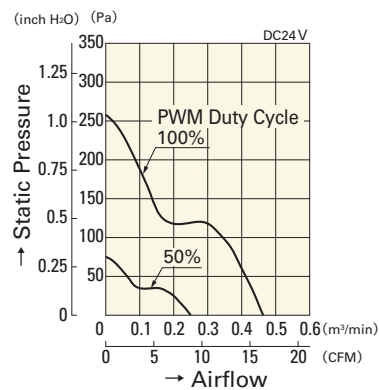

9GA0424P3M001

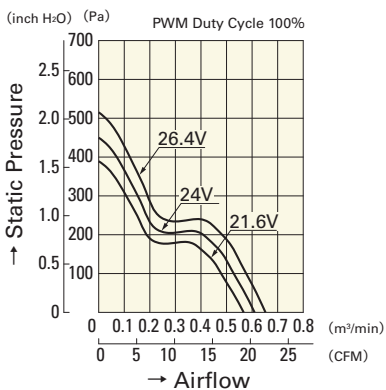

9GA0424P3G001

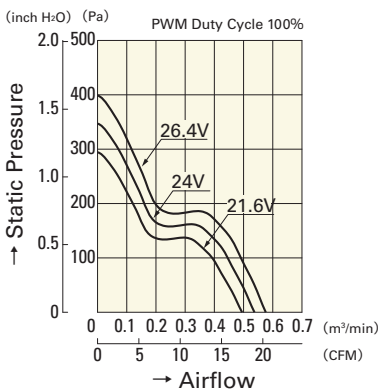

9GA0424P3H001

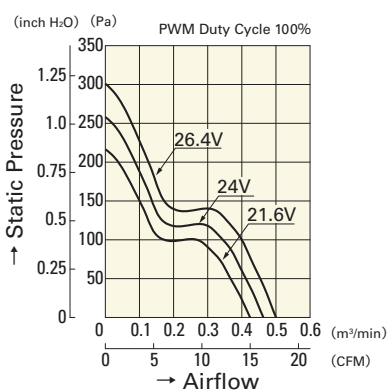

9GA0424P3M001

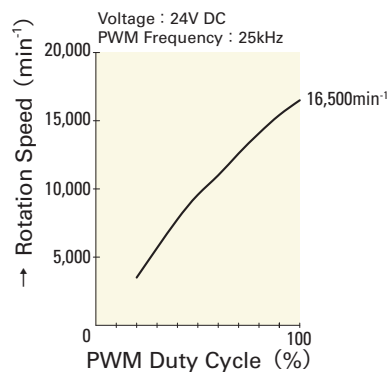

9GA0424P3G001

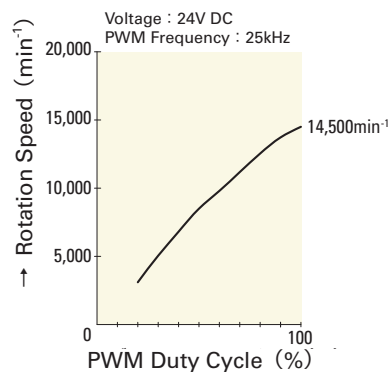

9GA0424P3H001

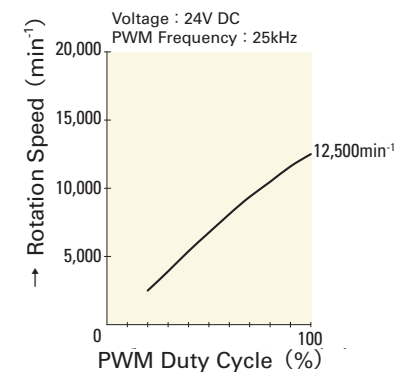

9GA0424P3M001