

40mm sq.

San Ace 40

10mm thick, 15mm thick (GA type), 15mm thick,
 20mm thick (GA type), 20mm thick
 28mm thick (GA type), 28mm thick (GE type)
 28mm thick (GV type), 28mm thick



General Specifications

- Material Frame: Plastics (Flammability: UL94V-0),
 Impeller: Plastics (Flammability: UL94V-0)
- Expected Life Refer to specifications (L10: Survival rate: 90% at 60°C ,
 rated voltage, and continuously run in a free air state)
- Lead Wire ⊕red ⊖black (Sensor) yellow (Control) brown
- Storage Temperature -30°C to +70°C (Non-condensing)

40×40×20mm (Mass : 35g) **GA type** High Air Flow Low Power Consumption Fan



Specifications The following nos. have PWM controls, pulse sensors, and ribs.

Model No.	Rated Voltage [V]	Operating Voltage Range [V]	PWM duty cycle* [%]	Rated Current [A]	Rated Input [W]	Rated Speed [min ⁻¹]	Max. Air Flow [m ³ /min] [CFM]	Max. Static Pressure [Pa] [inchH ₂ O]	SPL [dB(A)]	Operating Temperature [°C]	Expected Life [h]
9GA0405P6H001 ^(Note)	5	4.5 to 5.5	100	0.35	1.75	12,400	0.33 11.7	191 0.77	40	-20 to +70	40,000
9GA0405P6F001 ^(Note)			100	0.18	0.9	8,000	0.21 7.4	79.5 0.32	28		60,000
9GA0412P6G001	12	10.2 to 13.8	100	0.23	2.76	16,000	0.42 14.8	318 1.28	47		40,000
			0	0.04	0.48	3,800	0.10 3.5	17.9 0.07	14		60,000
100			0.14	1.68	12,400	0.33 11.7	191 0.77	40			
0			0.04	0.48	3,800	0.10 3.5	17.9 0.07	14			
100			0.08	0.96	8,000	0.21 7.4	79.5 0.32	28			
0			0.03	0.36	2,200	0.06 2.1	6.0 0.02	10			
9GA0424P6G001 ^(Note)	24	20.4 to 27.6	100	0.13	3.12	16,000	0.42 14.8	318 1.28	47		40,000
9GA0424P6H001 ^(Note)			100	0.08	1.92	12,400	0.33 11.7	191 0.77	40		60,000
9GA0424P6F001 ^(Note)			100	0.04	0.96	8,000	0.21 7.4	79.5 0.32	28		

Note: Rated voltage 5V and 24V fans do not rotate when PWM duty cycle is 0%.

*PWM Frequency : 25kHz

Available options: ⇒ **Without Sensor** **Pulse Sensor**

Dimensions (Unit : mm)

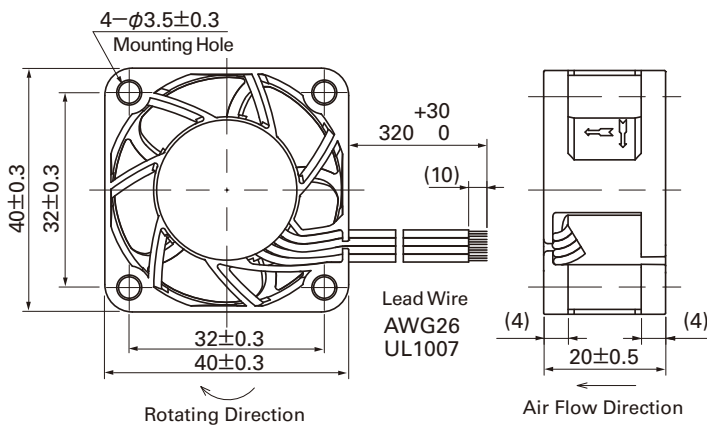

Reference dimension of mounting holes and vent opening (Unit : mm)

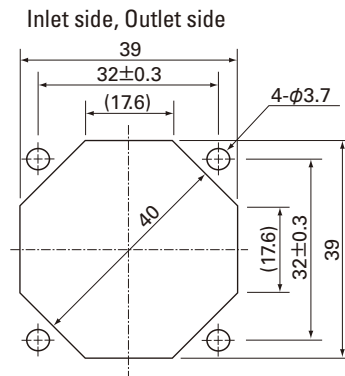

Options (Unit : mm)

Finger guards

Model : 109-059 Surface treatment : Nickel-chrome plating (silver) Color

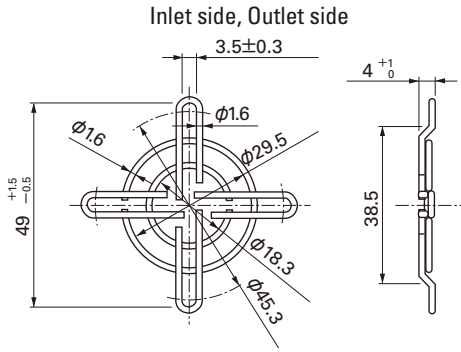

Air Flow - Static Pressure Characteristics

PWM Duty Cycle

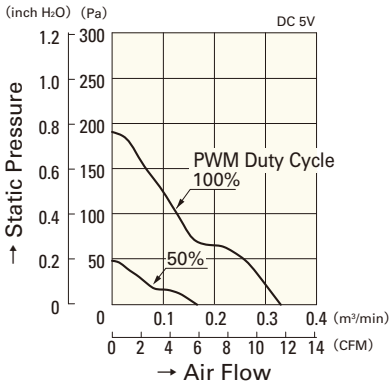

9GA0405P6H001

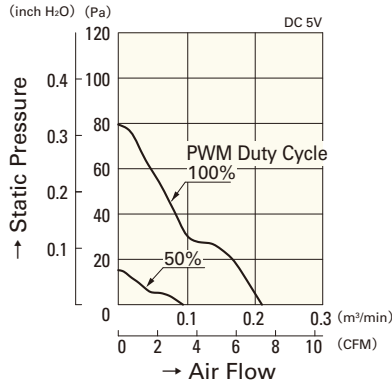

9GA0405P6F001

Operating Voltage Range

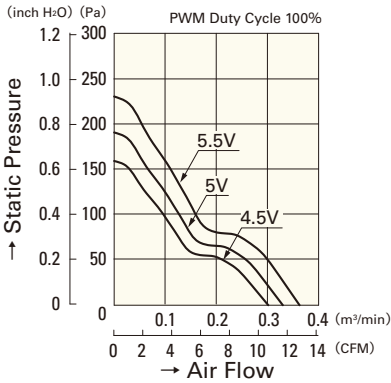

9GA0405P6H001

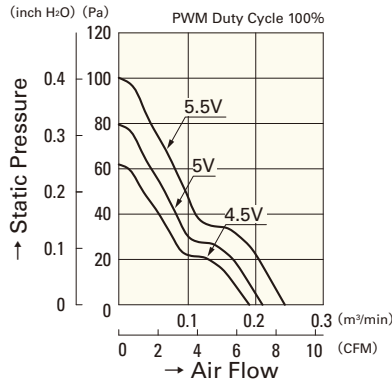

9GA0405P6F001

PWM Duty - Speed Characteristics Example

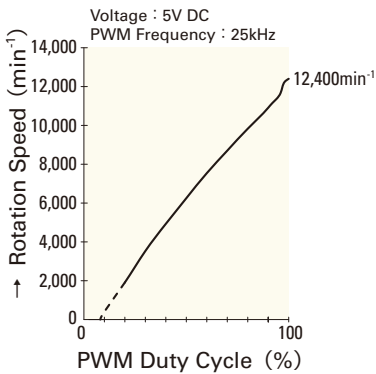

9GA0405P6H001

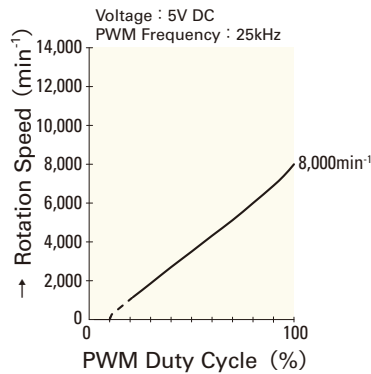

9GA0405P6F001

40mm sq.

San Ace 40

40×40×20mm [Mass : 35g]

Air Flow - Static Pressure Characteristics

PWM Duty Cycle

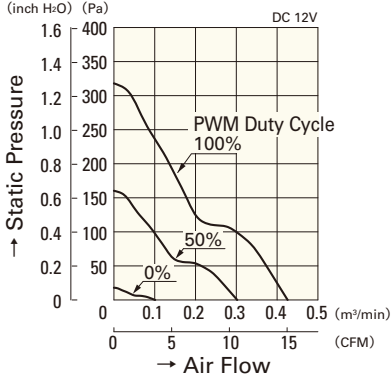

9GA0412P6G001

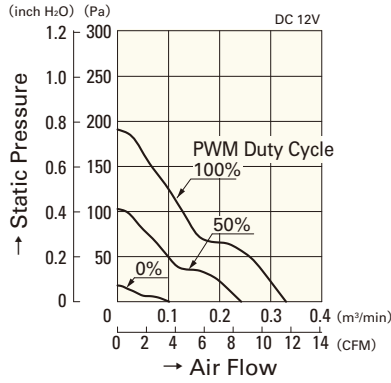

9GA0412P6H001

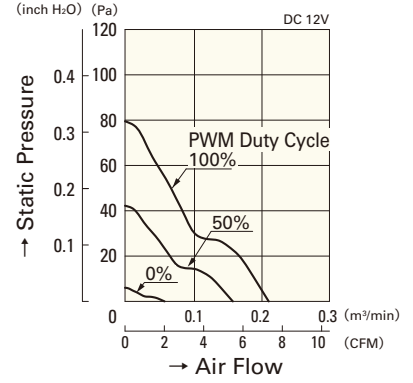

9GA0412P6F001

Operating Voltage Range

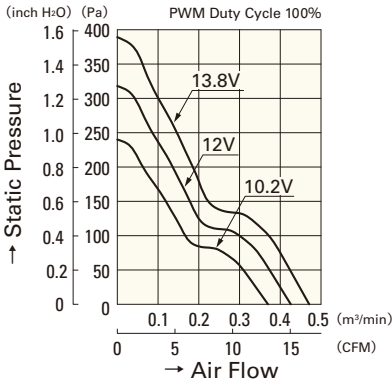

9GA0412P6G001

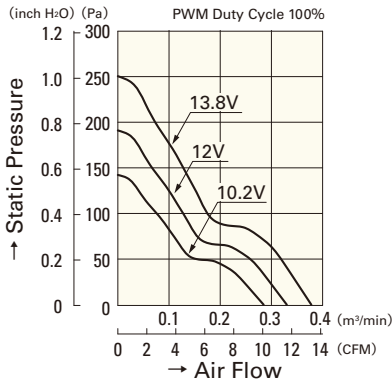

9GA0412P6H001

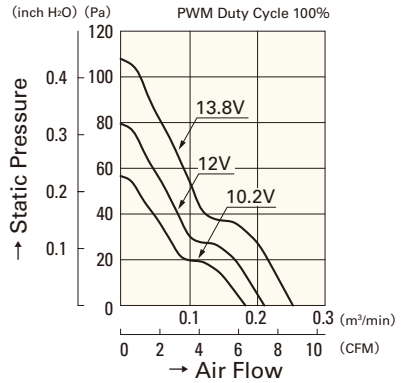

9GA0412P6F001

PWM Duty - Speed Characteristics Example

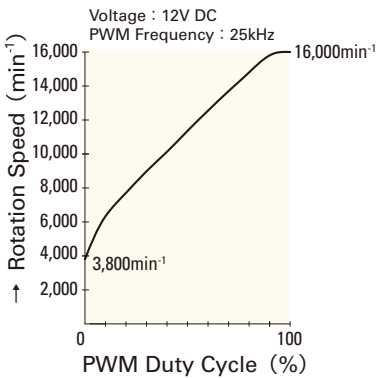

9GA0412P6G001

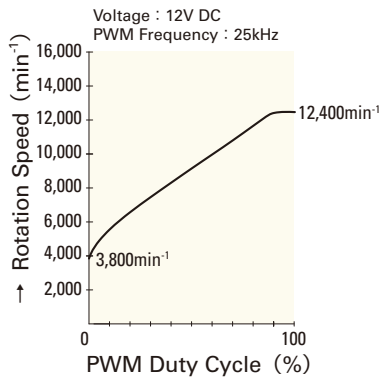

9GA0412P6H001

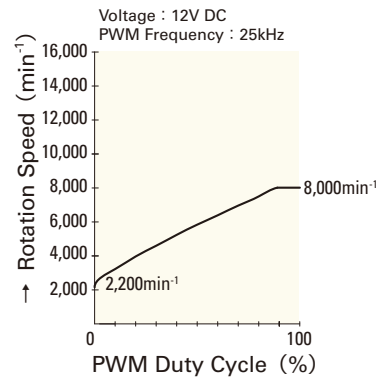

9GA0412P6F001

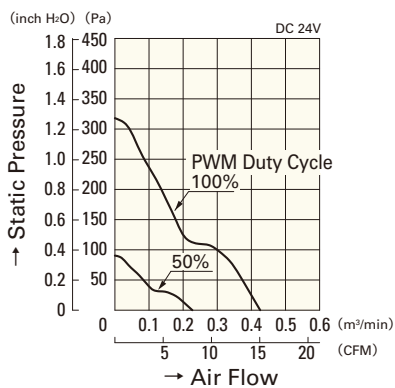

9GA0424P6G001

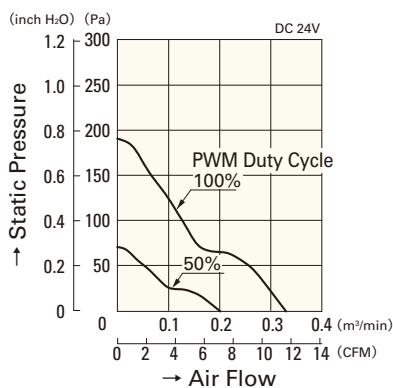

9GA0424P6H001

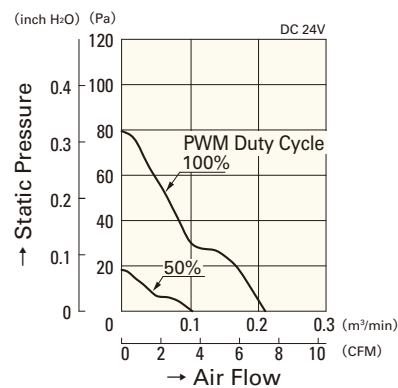

9GA0424P6F001

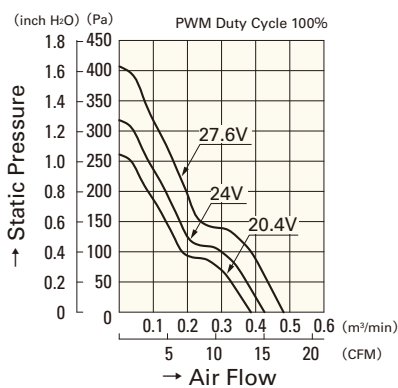

9GA0424P6G001

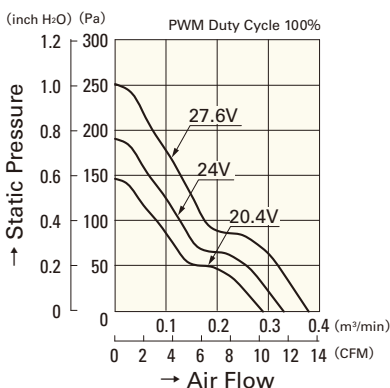

9GA0424P6H001

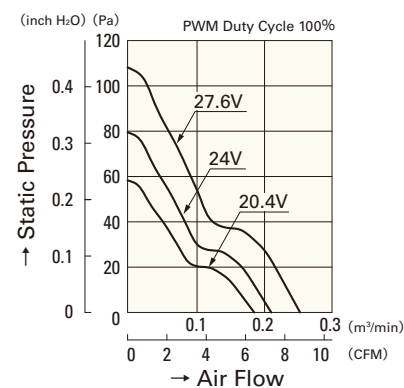

9GA0424P6F001

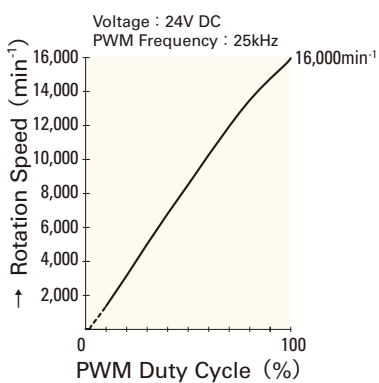

9GA0424P6G001

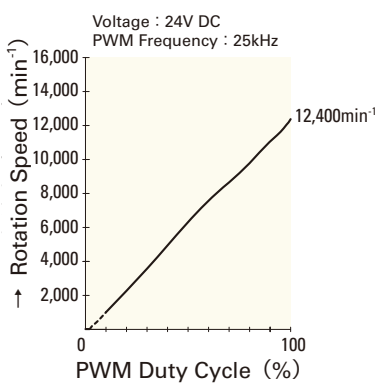

9GA0424P6H001

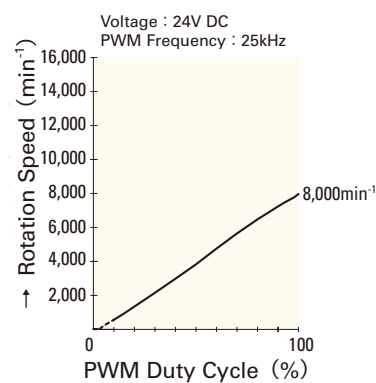

9GA0424P6F001