

80mm sq.

San Ace 80

80mm thick (9CRA type)



General Specifications

- Material Frame: Plastics (Flammability: UL94V-0),
Impeller: Plastics (Flammability: UL94V-0)
- Expected Life Refer to specifications (L10:Survival rate:90% at 60°C ,
rated voltage, and continuously run in a free air state)
- Lead Wire Inlet ⊕red ⊖black (Sensor) yellow (Control) brown
Outlet ⊕orange ⊖gray (Sensor) purple (Control) white
- Storage Temperature -30°C to +70°C (Non-condensing)

80×80×80mm (Mass : 450g) **9CRA type**

Specifications The following nos. have PWM controls and pulse sensors.

Model No.	Rated Voltage [V]	Operating Voltage Range [V]	PWM duty cycle※ [%]		Rated Current [A]	Rated Input [W]	Rated Speed [min ⁻¹]		Max. Airflow [m ³ /min] [CFM]		Max. Static Pressure [Pa] [inchH ₂ O]		SPL [dB(A)]	Operating Temperature [°C]	Expected Life ^{nom} [h]
			100	0			Inlet	Outlet	4.5	158.9	1,150	4.62			
9CRA0812P8G001	12	10.8 to 13.2	100	0	5.3	63.6	12,000	11,300	4.5	158.9	1,150	4.62	76	-20 to +70	40,000/60°C (70,000/40°C)
					0.2	2.4	2,000	1,900	0.74	26.1	31.9	0.13	30		
9CRA0848P8G001	48	40.8 to 55.2	100	0	1.32	63.4	12,000	11,300	4.5	158.9	1,150	4.62	76	-20 to +70	40,000/60°C (70,000/40°C)
					0.29	13.9	5,000	4,700	1.88	66.2	200	0.80	52		

Note: Expected life at 40°C ambient is just reference value.

※PWM Frequency : 25kHz

Some models can also be equipped with pulse sensors (no PWM control functions) as an option. Please refer to the index (pp. 417 to 437).

Dimensions (unit : mm)

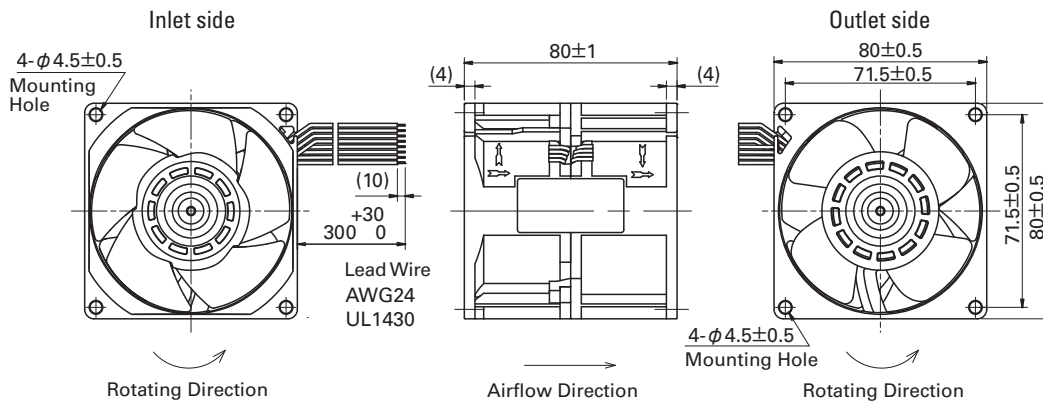

Reference Dimension of Mounting Holes and Vent Opening (unit : mm)

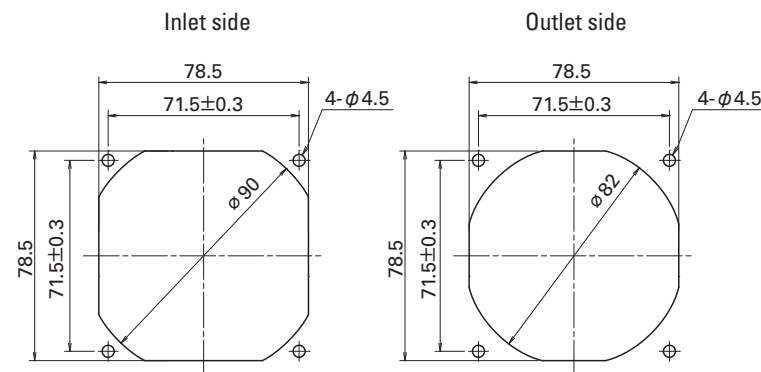

Options (unit : mm)

Finger Guards

Model : 109-049C Surface treatment : Nickel-chrome plating (silver) Color (silver)

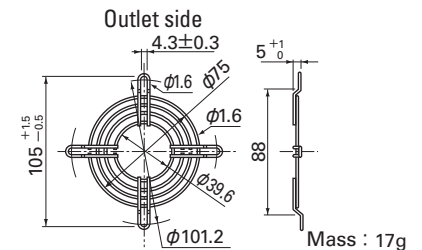

Model : 109-049E Surface treatment : Nickel-chrome plating (silver)
: 109-049H : Cation electropainting (black)

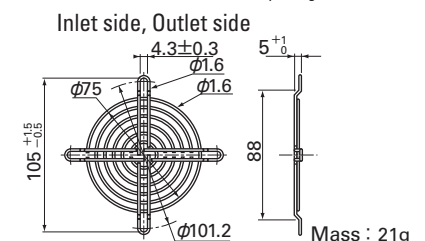

Options (unit : mm)

Resin Finger Guards

Model : 109-1002G

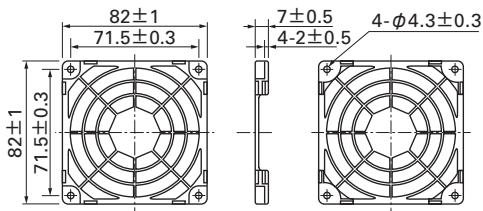

Mass : 10g

Resin Filter Kits

Model : 109-1002F13 (13PPI), 109-1002F20 (20PPI)
: 109-1002F30 (30PPI), 109-1002F40 (40PPI)

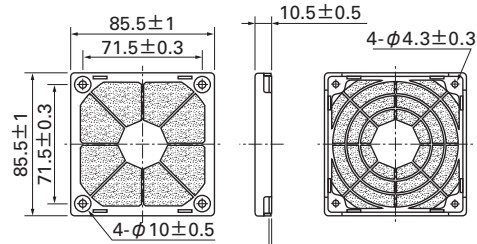

Mass : 19g

Airflow - Static Pressure Characteristics

PWM Duty Cycle

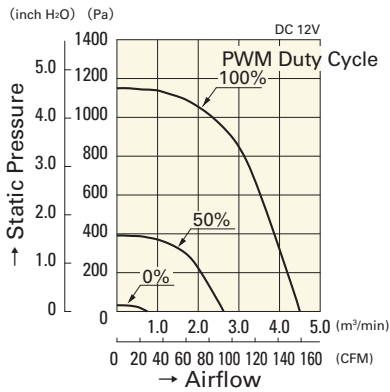

9CRA0812P8G001

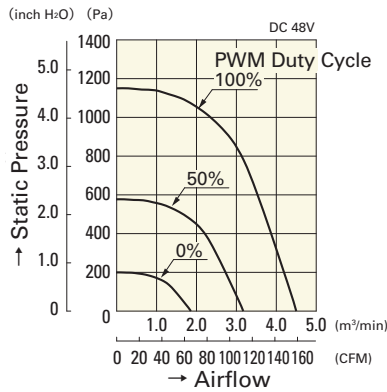

9CRA0848P8G001

Operating Voltage Range

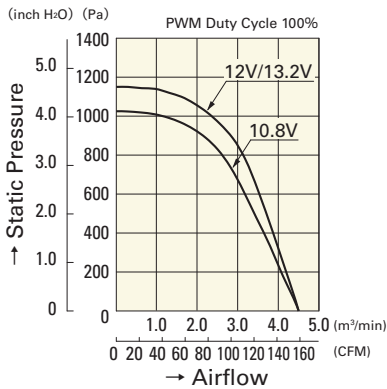

9CRA0812P8G001

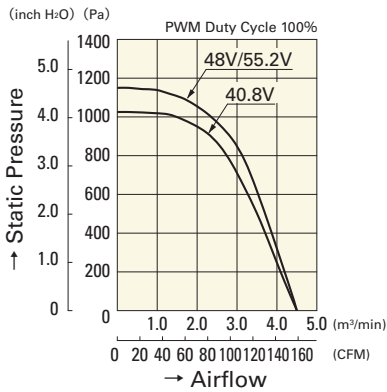

9CRA0848P8G001

PWM Duty - Speed Characteristics Example

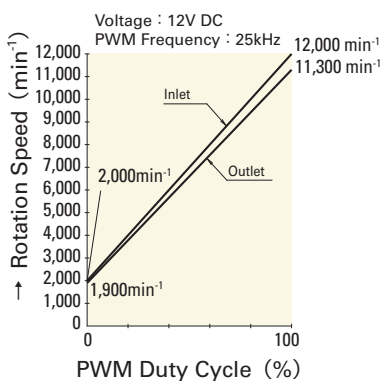

9CRA0812P8G001

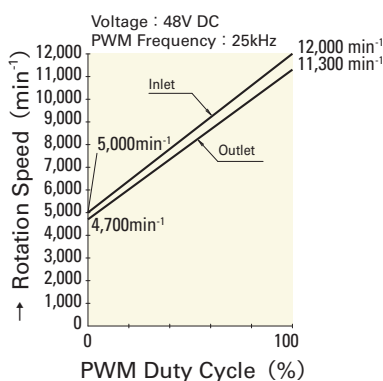

9CRA0848P8G001